



QStreet Pro

Street Lighting 20/30/40/50W

Technical

• Input Voltage	AC 100-277V
• Beam Spread	85*155°
• CRI	>70
• Power Factor	>0.98
• Operating Temp.	-40°C to +50°C
• Materials	Aluminium With Tempered Glass
• IP Rating	IP66
• IK Rating	IK08 (Glass)
• Surge Protection	10Kv
• Dimmable	On Request
• Lifetime	100,000 hours, L90-B10 (Ta 25 °C)
• Salt & Spray Test	720hrs (35°C)
• Emergency Output	N/A

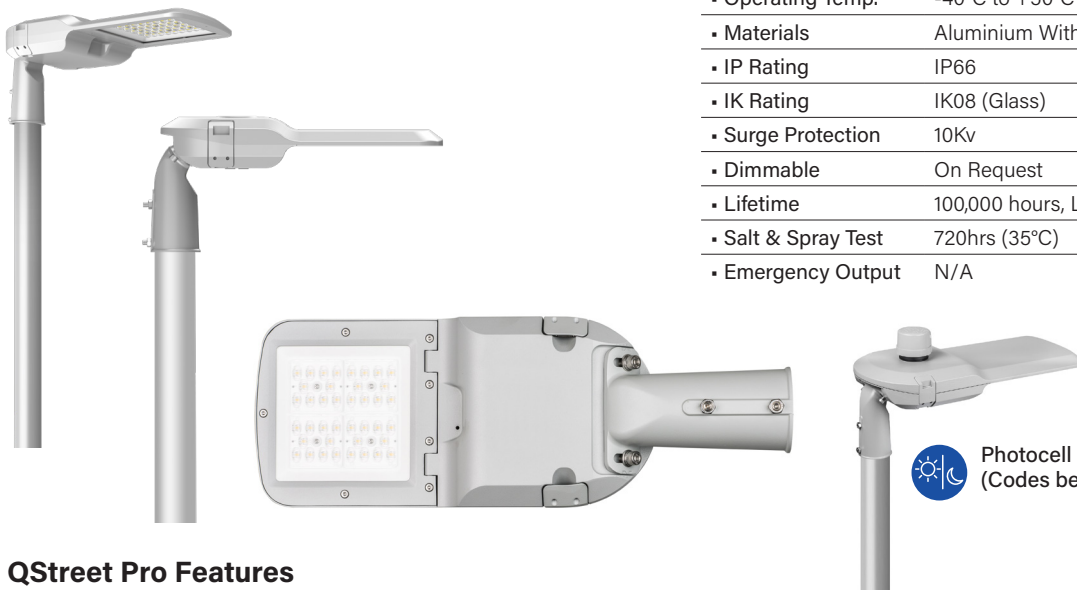

Photocell Available (Codes below)

QStreet Pro Features

- IP66 Ingress Protection
- 10Kv Surge Protection
- Wattage & Colour Switchable
- 60mm/76mm Spigot
- Adjustable Head -15° - +15°
- 10m Cable Flex

Part Code: QST3-PRO-20/30/40/50-TC/FX - Standard Options

Power	Windage	Efficacy	Output	Kelvin
20W	0.0599m ²	170Lm/cW	3400Lm	Tri-Colour: 2700K, 4000K & 6500K
30W	0.0599m ²	170Lm/cW	5100Lm	
40W	0.0599m ²	170Lm/cW	6800Lm	
50W	0.0599m ²	170Lm/cW	8500Lm	

Net Weight | 3.3kg

Part Code: QST3-PRO-20/30/40/50-TC/PH - Photocell Options

Power	Windage	Efficacy	Output	Kelvin
20W	0.0599m ²	170Lm/cW	3400Lm	Tri-Colour: 2700K, 4000K & 6500K
30W	0.0599m ²	170Lm/cW	5100Lm	
40W	0.0599m ²	170Lm/cW	6800Lm	
50W	0.0599m ²	170Lm/cW	8500Lm	

Net Weight | 3.4kg

Options	Option Code
DALI 2.0 Dimmable	+/D
Bespoke Columns	Quoted to suit



SILVAIR CASAMBI

Dimensions FX

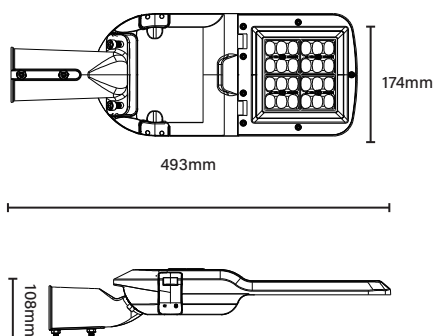

Dimensions PH

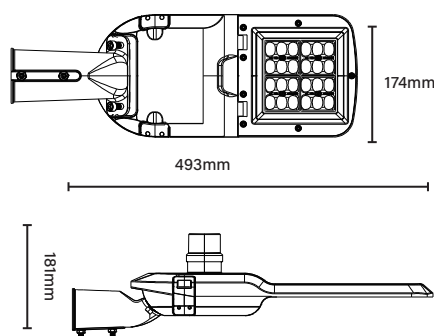

Photometric Data

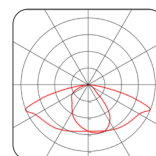

Energy Efficiency Rating

